

Show Cage Sizes—Bengalese

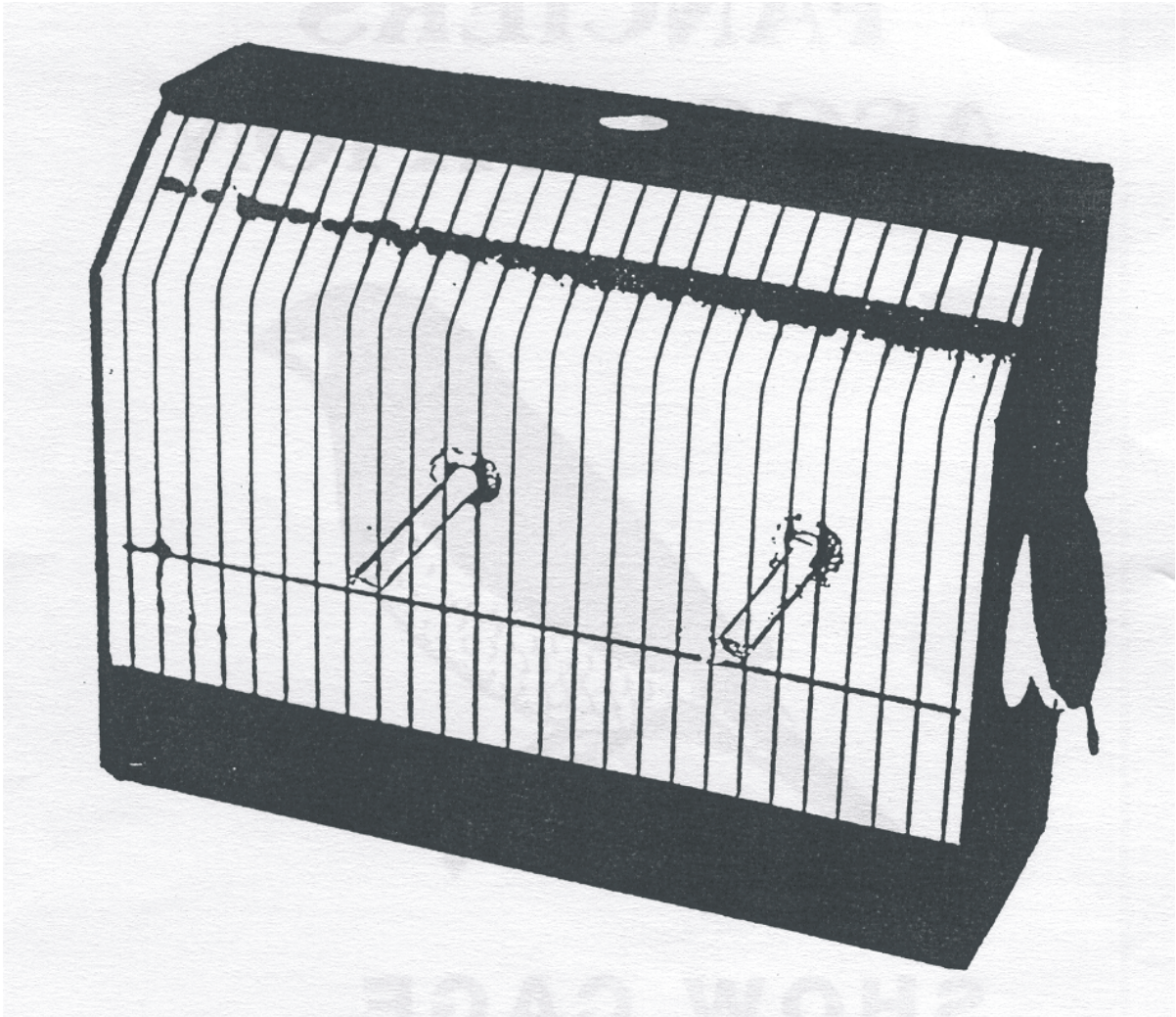

This fact sheet details the specification of the Show Cage that is required to exhibit Bengalese in the United Kingdom.

Other fact sheets in this series are available covering the requirements for other species of birds.



SIZE

Overall measurement—333 mm long, 266 mm high and 125 mm wide.

WOOD

Sizes as per drawings. Top, sides, bottom, sloping false roof and front rail, good quality 6 mm thick timber or ply. The back can either be 4 mm or 6 mm good quality timber or ply.

PERCHES

Are of 9 mm diameter dowel, with a 28 mm diameter timber boss projecting 9 mm, overall length of perch 102 mm.

DRINKER

This is made of metal, sizes as per drawing, it has a wire loop twist (acts as handle), the ends bent to locate drinker in side of cage, the drinker is held in place by 22 mm desk turn. The parts of drinker which project into the cage to be painted white, the end of the drinker outside the cage to be painted black gloss. An all plastic drinker is also acceptable.

CAGE FRONT

Comprises 25 bars, 1.5 mm diameter wire, 12 mm centre to centre, double punch bar at top 15 mm apart, one punch bar located 51 mm from base punch bar refer to drawing for exact details. Front to be painted black gloss.

DOOR

The door is located at the right hand end, sizes as per drawing, door hinge 1.5 mm diameter wire as per drawing; the door is kept shut by means of a 1.5 mm diameter wire bent as per drawing. An alternative strap hinge 64 mm o/a x 11 mm wide may also be used.

PAINTING

Colour inside - white gloss or matt.
Colour outside - black high gloss.

CARRYING

The cage is carried by means of a 32 mm diameter finger hole in the centre of the top.

FLOOR COVERING

Foreign finch seed mix.

TOP

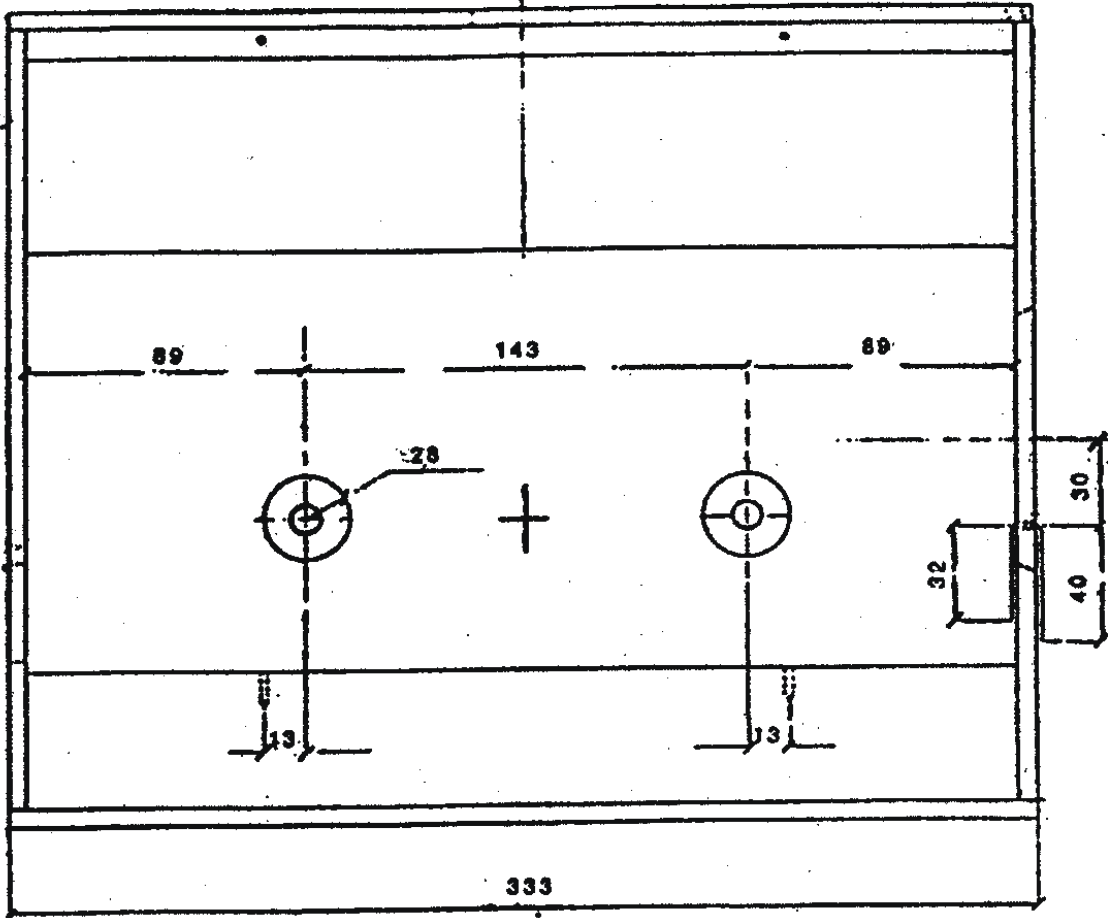
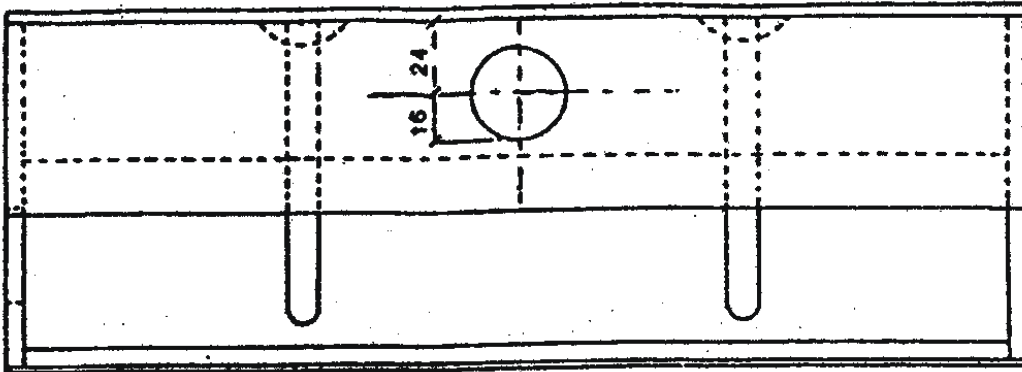

FRONT

LEFT SIDE

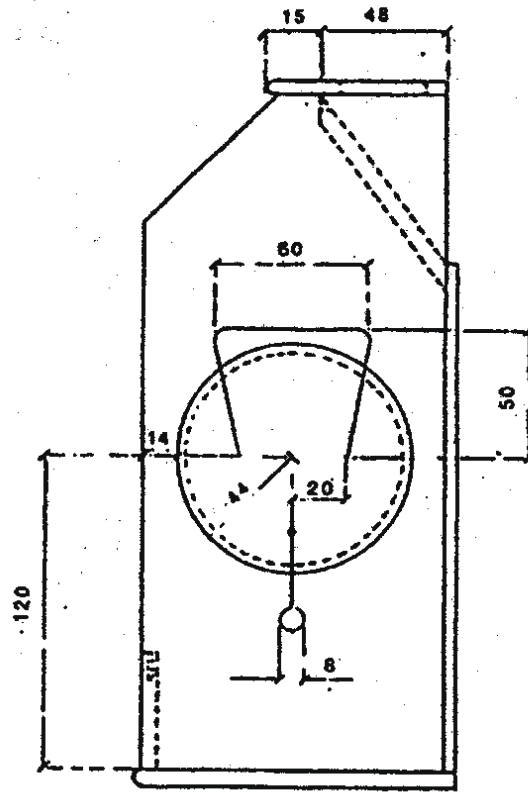
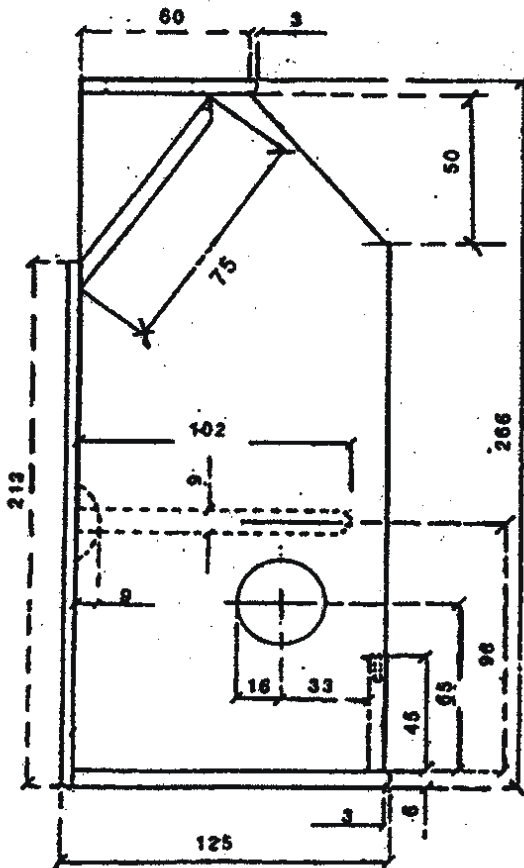

RIGHT SIDE

ALTERNATIVE DOOR FIXING

STRAP HINGE
64mm O/A LENGTH
X 11mm WIDE.

DRAWINGS NOT TO SCALE

WIRE CAGE FRONT

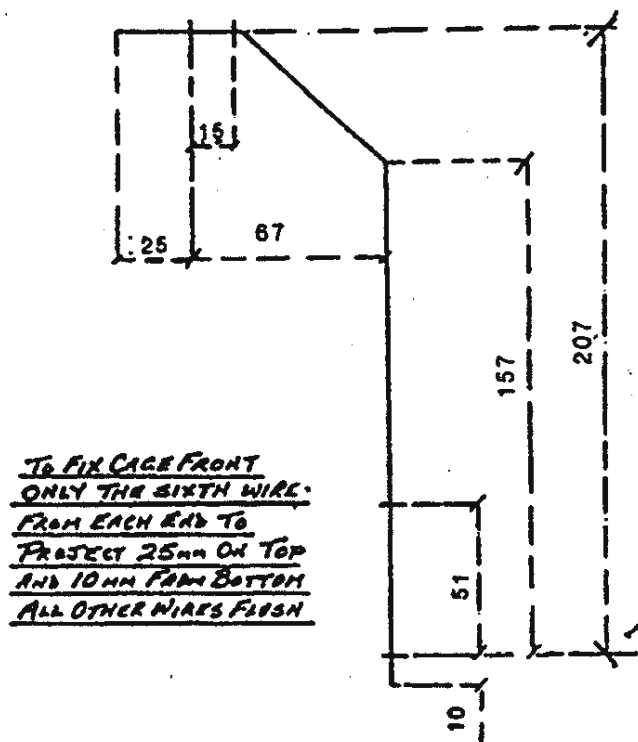
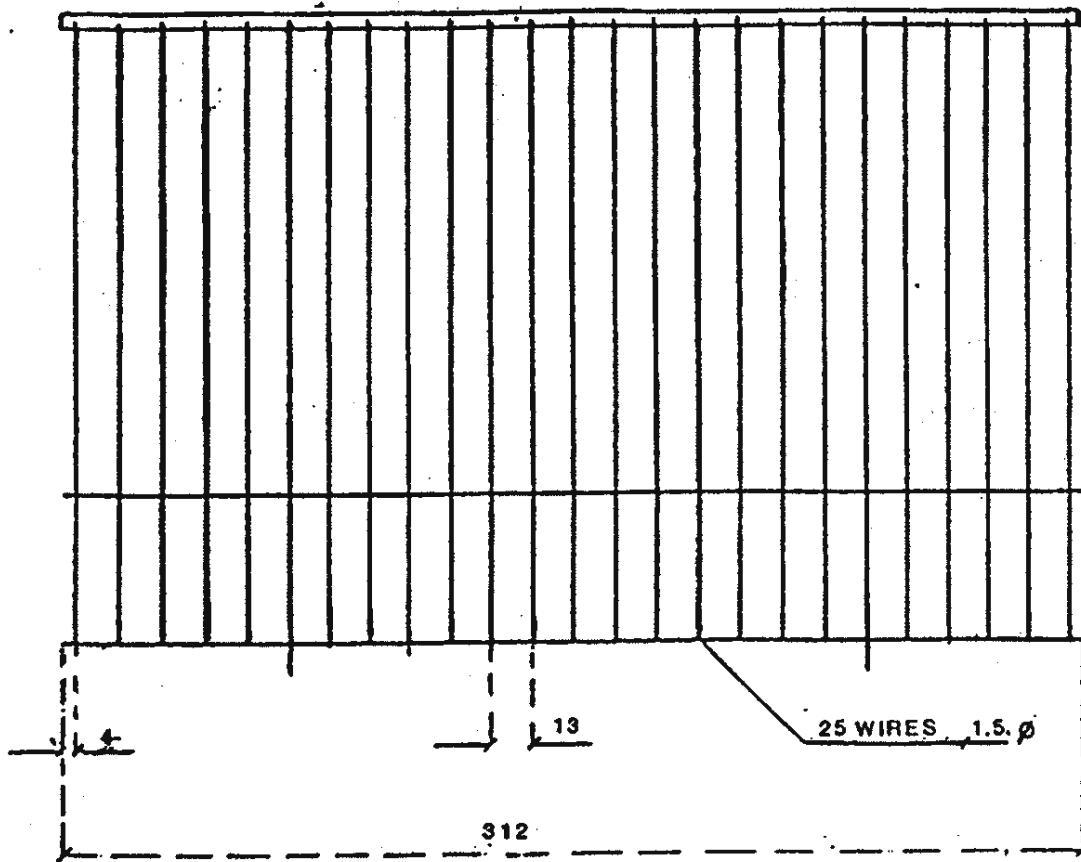

TO FIX CAGE FRONT
ONLY THE SIXTH WIRE
FROM EACH END TO
PROJECT 25mm ON TOP
AND 10mm FROM BOTTOM
ALL OTHER WIRES FLUSH

STANDARD SHOW CAGE ACCESSORIES

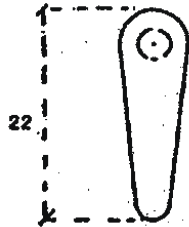

DESK TURN TO HOLD DRINKER

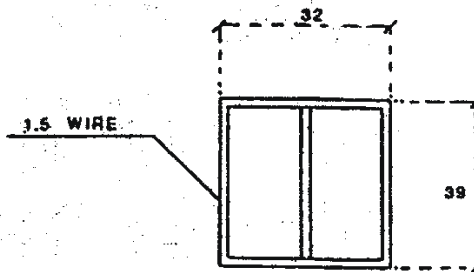

WIRE TRAP FOR DRINKER HOLE

DRINKER (metal).

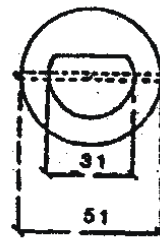
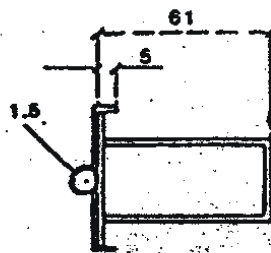
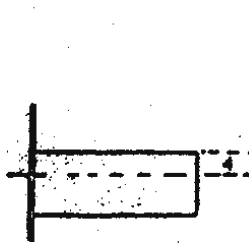

MOLDED PLASTIC DRINKER

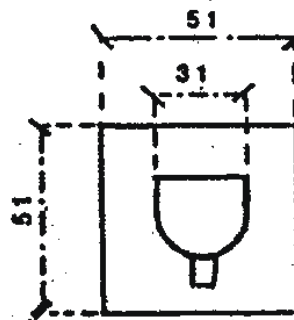
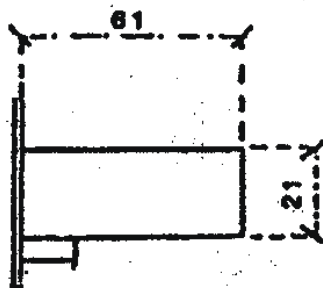

This fact sheet has been produced for:
The NCA —Spring Gardens, Northampton NN1 1DR
www.nca.uk.net